



Inverted Routine Microscope ECLIPSE Ts2

ECLIPSE Ts2

Inverted Routine Microscope





Do more

Fits in every Laboratory

Easy to work with

Efficient and comfortable observation

LED light sources and built-in Diascopic/Epi-fluorescence illumination systems reduce setup time and allow users to concentrate on their research.

New streamlined operation

Control buttons on the Ts2 microscope are intuitively located for a streamlined workflow. Commonly used controls such as the on/off and diascopic/epi-fluorescence switching buttons are located at the front panel for easy reach. Buttons pertaining to either diascopic or epi-fluorescence control are zoned to the left and right sides of the microscope body, respectively, to eliminate confusion and improve workflow efficiency.



Faster, brighter images with LED illumination

LED light source is alignment-free resulting in faster setup and consistent results. LEDs also eliminate frequent bulb replacements, saving the user time and money. Moreover, The new Contrast Shield (optional) provides high signal-to-noise fluorescence observation even in brightly lit culture rooms.



Easy-to-use Mechanical Stage

The high performance mechanical stage (optional) can accommodate a wide range of flasks and cell culture chambers. The new stage design also directly accommodates micro plates. In addition, the sample holder is easily removed to accommodate large flasks.





than before

— Simple to Use & Compact

Compact, streamlined body for efficient observation

LED-based high-quality diascope and epi-fluorescence observation

Two models are available to meet your needs: a diascope illumination model, the Ts2, and an epi-fluorescence illumination model, the Ts2-FL. High-intensity LED sources are employed for both diascope and epi-fluorescence illumination.

The built-in fly-eye lens ensures uniform brightness across the entire field of view. A wide range of wavelengths is available to choose from for Epi-fluorescence LED illumination.

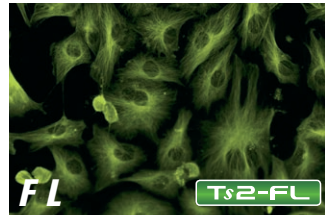
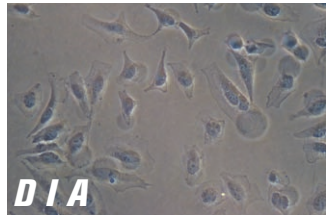

Compact and highly stable body

Illumination modules including the epi-fluorescence light source have been seamlessly incorporated into the microscope main body, resulting in a compact and simple design form that's also durable. The compact structure is also vibration-resistant to provide highly stable sample observations.

The camera port is located on the side of the microscope to provide unimpeded viewing of the stage even when placed inside a culture hood.



Ts2

Diascope illumination model



Ts2-FL

Diascope and epi-fluorescence illumination model

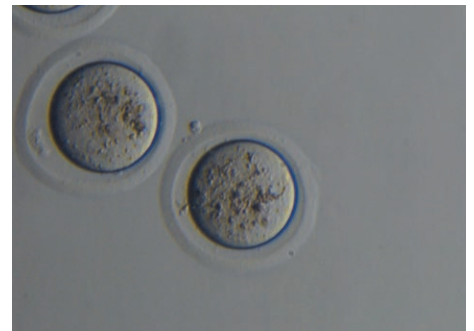
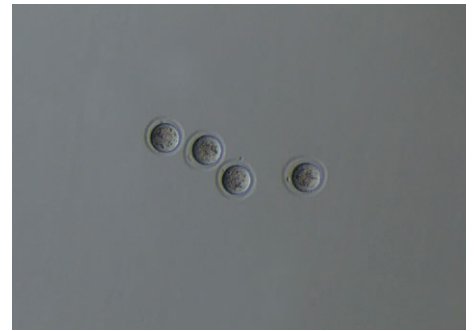
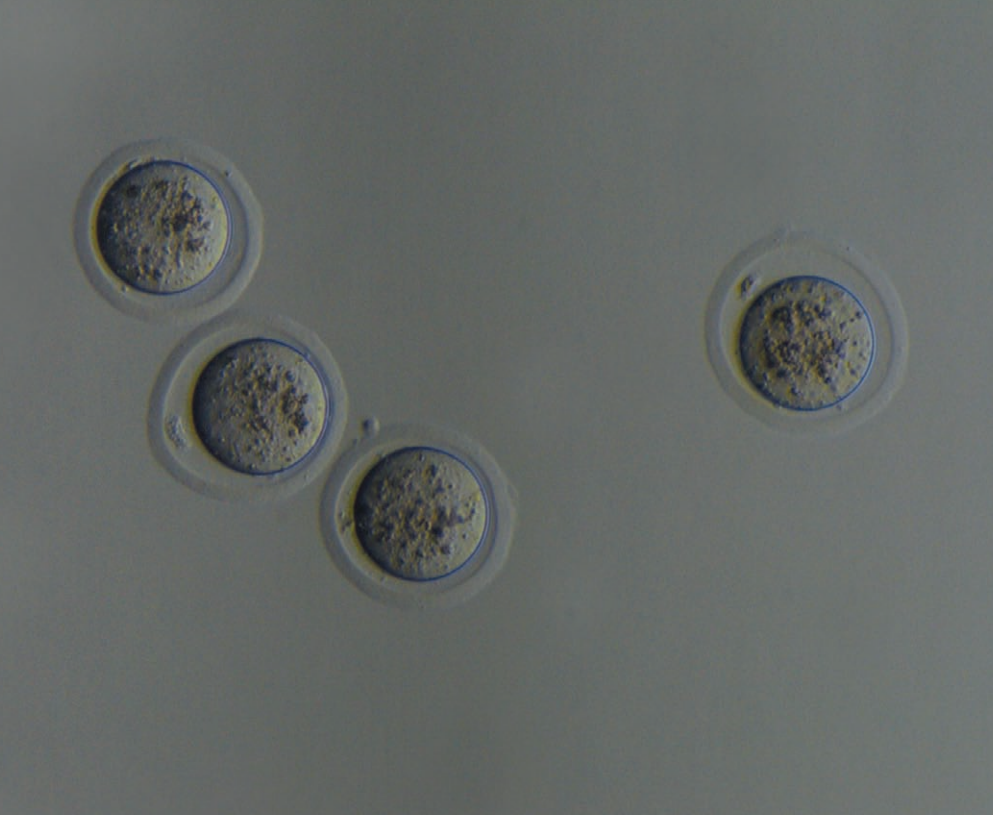

Do more than before — DIA

Ts2 Ts2-FL

Highly optical performance with diascopic observation

Diascopic observation with high-intensity LED (Eco-illumination)

Eco-illumination provides high-intensity light suitable for phase contrast observation. With the built-in fly-eye lens, uniform brightness is provided across the entire field of view. LEDs are an environmentally friendly, low-power-consumption light source. Eco-illumination provides a long lifetime of 60,000 hours and reduces the frequency of lamp replacement.

Phase contrast observation

Phase contrast is an optical contrasting technique that typically utilizes a phase contrast objective lens and condenser annulus. The use of a high-intensity LED light source results in clear images even at high magnifications.

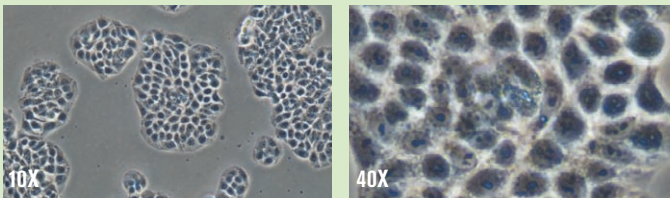

Apodized Phase Contrast (APC) observation

APC observation is a type of phase contrast microscopy which minimizes unwanted halos in thick specimens. For example, APC technique provides clearer details of thick samples such as dividing cells.

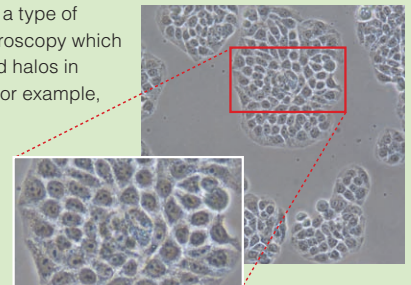

New contrasting technique, "Emboss Contrast"

Emboss Contrast is a cost-effective optical technique which does not require costly optics. Utilizing just a bright-field objective lens and two contrast sliders, Emboss Contrast provides pseudo-three dimensional and glare-free images for thick specimens such as iPS cells which would normally suffer from halos with conventional phase contrast methods. Additionally, Emboss Contrast is compatible with both glass and plastic culture chambers, making it a very versatile observation technique.

Comparison of new Emboss Contrast and Nikon Advanced Modulation Contrast

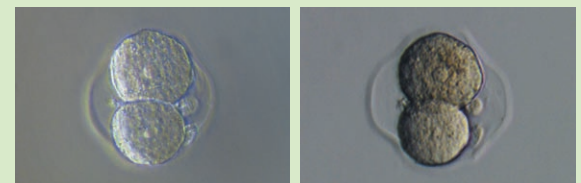

NAMC / 20X

Emboss Contrast / 20X

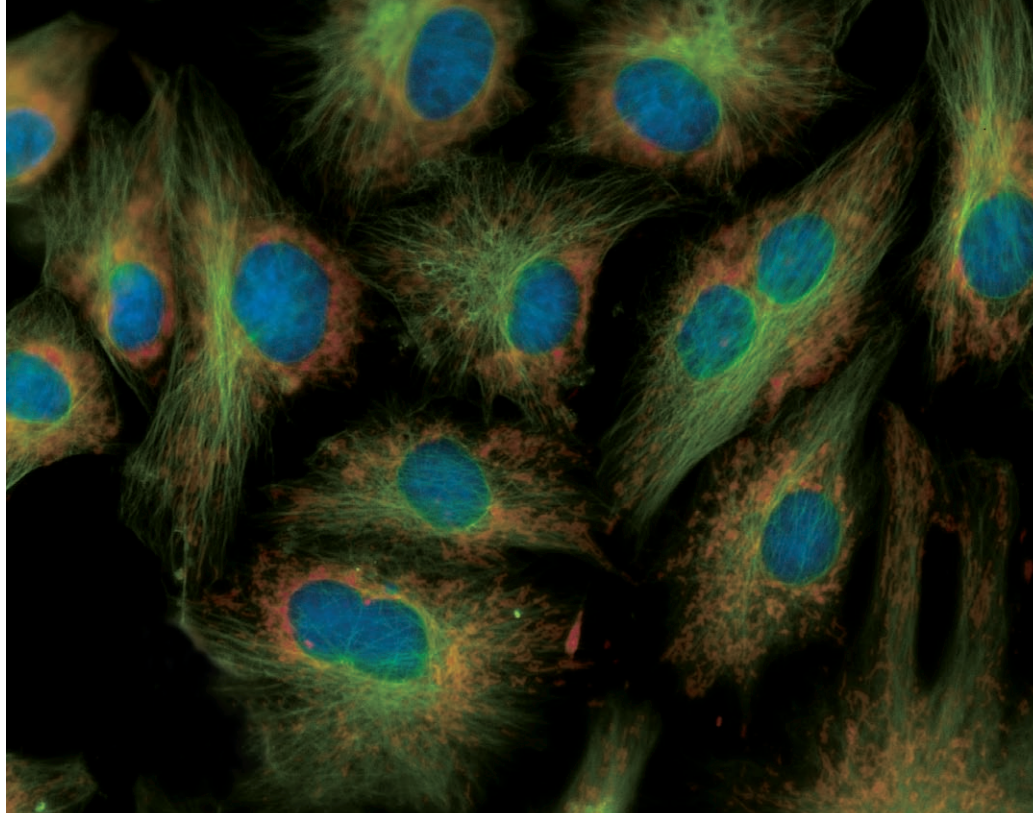
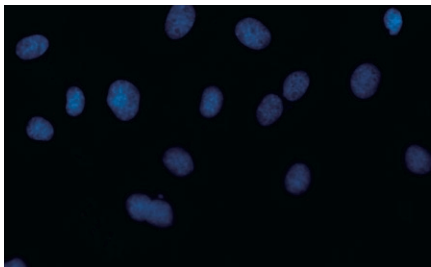
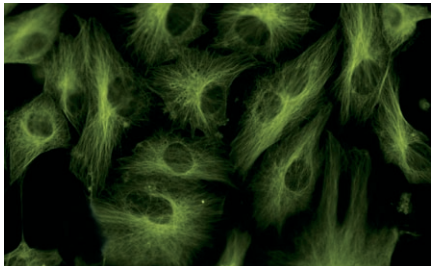
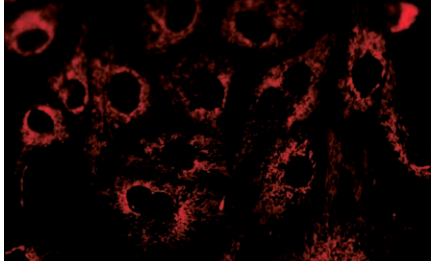

Overlapping image with three colors with use of imaging Software NIS-Elements

Do more than before — **FL**

Ts2-FL

Epi-fluorescence observation made easy with LED

Fly-eye lens for uniform illumination

With a built-in fly-eye lens, uniform brightness is provided across the entire field of view.

Accurately reproduce illumination power every time

The Ts2 can be configured with up to three fluorescent filter cubes. The illumination power previously defined by the user is replicated when the same wavelength is used again, thus eliminating the need for manual adjustment of light intensity when switching between wavelengths. The Ts2 also incorporates a noise terminator mechanism which allows high signal-to-noise fluorescent images to be captured.

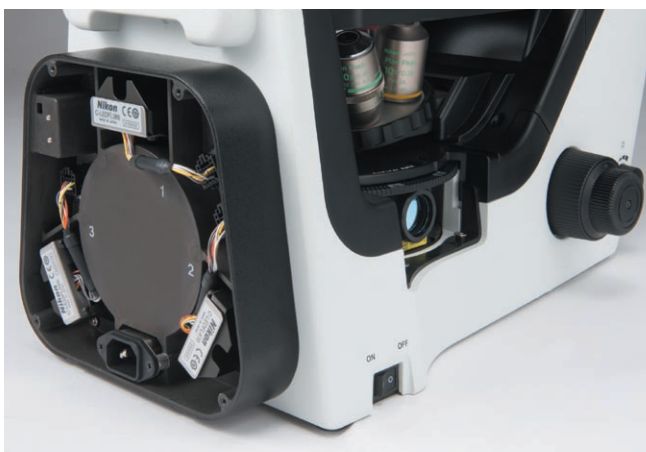

High S/N epi-fluorescence observation in bright rooms

The new Contrast Shield accessory (optional) blocks room light, providing an easy and cost-effective method for achieving high signal-to-noise fluorescence observation in a brightly lit culture room.

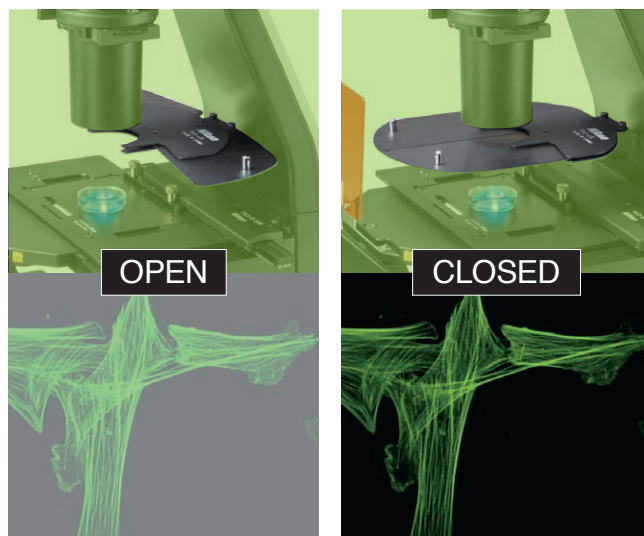

Accessories

Camera Port

Optional camera port is available for image capturing. Digital Cameras utilizing C- or F-mounts can be attached.



Emboss Contrast Slider

Both condenser-side slider and eyepiece-tube-side slider are available. Contrast modules for 10X, 20X, 40X objective lenses are arranged on the same slider so switching between magnifications is easily achieved by simply sliding the contrast slider.



Thermo Plate TPX (for the Mechanical Stage)

Thermo plate TPX provides accurate and stable temperature control for the specimen from room temperature to 50 degrees Celsius. Proprietary treatment methods ensure that the glass surface of the Thermo Plate is breakage-free.

Manufacturer: TOKAI HIT Co., Ltd.



Cameras for microscopes

Digital Sight Series

All cameras of the digital sight series can be directly connected to a PC via a fast USB3.0 interface.

*The optional camera port is required to attach the digital camera to the microscope. Please see the Digital Sight.



Configuration of Ts2+DS-Fi3+DS-L4 ▶

F-mount CMOS Camera

Microscope camera **DS-Ri2**

Capable of expressing images as is, this microscope digital camera offers high resolution, superior color reproduction and fast frame rate.

16.25 megapixel Color High-resolution



Monochrome Microscope camera **DS-Qi2**

Capable of expressing images as is, this microscope digital camera offers high-sensitivity, and low noise imaging.

16.25 megapixel Monochrome Cooled



Frame rate	6 fps (4908 × 3264), 45 fps (1636 × 1088)
Max recordable pixels	4908 × 3264

C-mount CMOS Camera

Microscope camera **DS-Fi3**

Capable of expressing images as is, this microscope digital camera offers high resolution, fast frame rate and high sensitivity.

5.9 megapixel Color High-resolution



Frame rate	15 fps (2880 × 2048), 30 fps (1440 × 1024)
Max recordable pixels	2880 × 2048

Camera control unit

Microscope camera control unit **DS-L4**

DS-Fi3 and DS-Ri2 can be optionally connected to the DS-L4 tablet-style control unit, eliminating the need and space requirements of a desktop PC. DS-L4 has a large number of built-in security for network connectivity.



System diagram

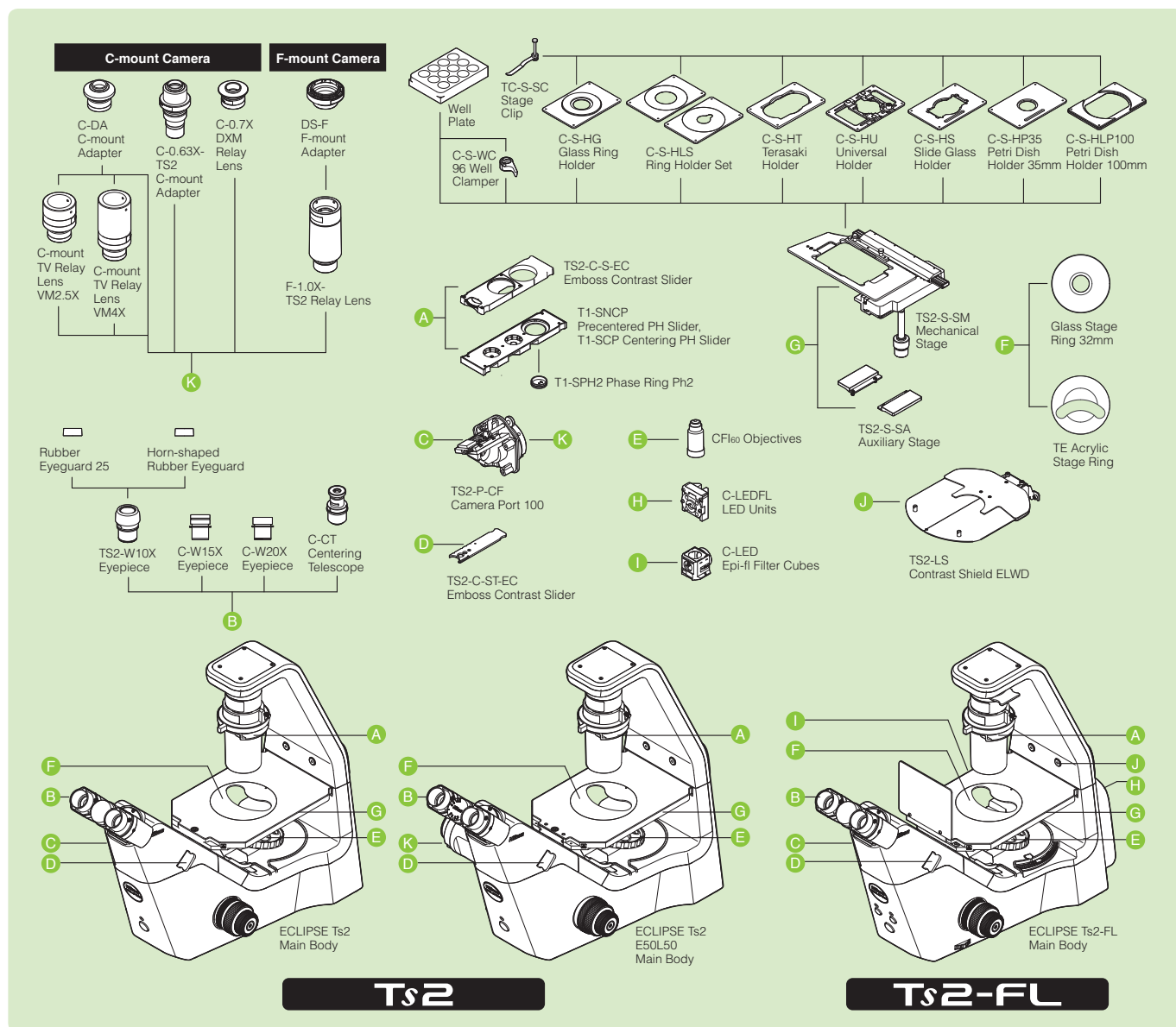

Dimensions (Unit: mm)

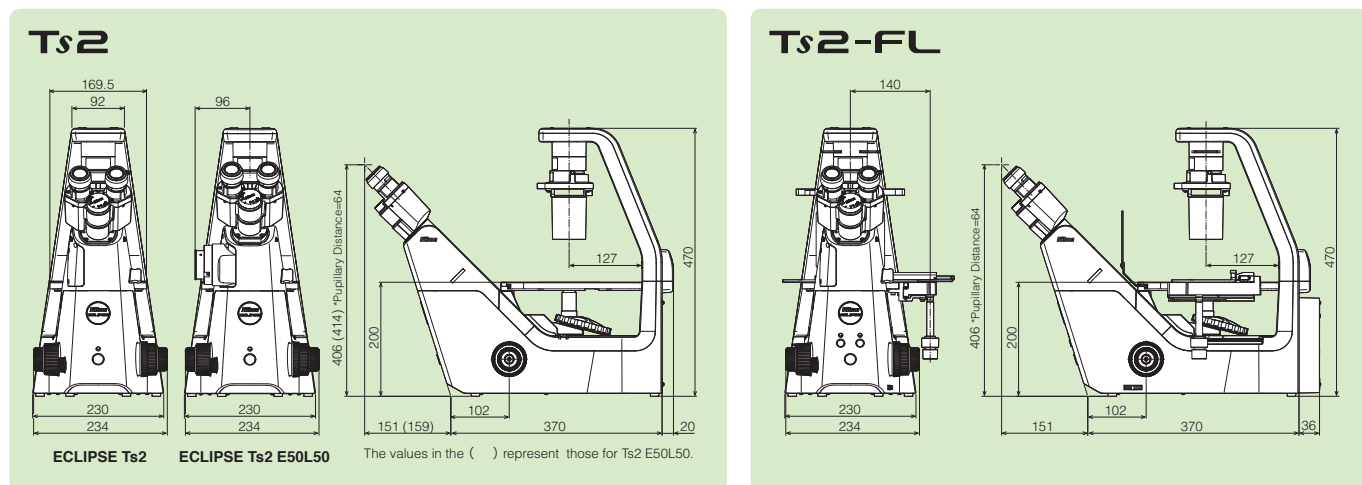

Ts2 / Ts2-FL Specifications

	Ts2	Ts2-FL
Optical System	CFI60 Infinity Optical System	
Observation method	Brightfield, Apodized Phase Contrast*1, Phase Contrast, Emboss Contrast*2	Brightfield, Apodized Phase Contrast*1, Phase Contrast, Emboss Contrast*2, Epi-Fluorescence
Illumination	Diascopic illumination	High luminescent white LED illuminator (Eco-illumination), Built-in Fly eye lens
	Episcopic illumination	— LED illuminator, built-in Fly eye lens. Can be configured with up to 3 different fluorescence LED units; available wavelengths: 385, 455, 470, 505, 525, 560, 590, 625 nm
Tube	Ts2 and Ts2-FL: Inclination: 45 degree, Pupillary distance: 50 - 75mm, Siedentopf type, Attachable camera port, Eyepiece/Port: 100/0:0/100 Ts2 E50L50: Inclination: 45 degree, Pupillary distance: 50 - 75mm, Siedentopf type, Fixed camera port , Eyepiece/Port: 50/50 only	
Eyepiece (F.O.V.)	10X (22), 15X (16), 20X (12.5)	
Focusing	Via nosepiece up/down movement, Stroke (manual): Up 7mm down 1.5mm Coarse stroke: 37.7mm per rotation, Fine stroke: 0.2mm per rotation, Coarse motion torque adjustable	
Nosepiece	Quintuple nosepiece	
Condenser	ELWD Condenser (NA 0.3, W.D. 75mm)	
Slider	<ul style="list-style-type: none"> • Precentered or Centering PH Slider, 10X, 20X, 40X Objectives available for phase contrast • Emboss Contrast sliders (both condenser-side slider and eyepiece-tube-side slider must be mounted), 10X, 20X, 40X objectives available for Emboss Contrast 	
Stage	<ul style="list-style-type: none"> • Plain Stage, stage size: 170(X)×247(Y) mm, With 2 Acrylic Types of Stage Ring • Mechanical stage (optional), stroke:126(X)×78(Y)mm, Accepts 5 types of micro-testplate, well clammer and stage clip 	
Holder	<ul style="list-style-type: none"> • C-S-HP35 Petridish Holder 35mm • C-S-HT Terasaki Holder for Terasaki holder and ø65 dish • C-S-HU Universal Holder for Terasaki plate holder, glass slide, ø35-65 dish and hemocytometer • C-S-HG Glass Ring Holder • C-S-HLP100 Petridish Holder 100mm • C-S-HS Slide Glass Holder for glass slides, ø54 dish and hemocytometer • C-S-HLS Ring Holder Set 	
Epi Fluorescence attachment	—	Epi-fluorescence filter turret (with main body), Filter cubes with noise terminator mechanism Configure with up to 3 Epi-fluorescence filter cubes, Additional positions for bright-field observation, Attachable Contrast Shield (optional)
Dimensions	236(W)×548(D)×471(H) mm	236(W)×564(D)×471(H) mm
Weight (approx.)	13kg	14.5kg
Rated Voltage/Electric Current	100V-240VAC±10%, 50/60Hz, 0.35A	
Power Consumption	15W	

*1 APC (Apodized Phase Contrast) is a type of phase contrast observation with reduced halo, thanks to Nikon's unique lens coating.

*2 Emboss contrast is Nikon's unique contrast observation method. It provides pseudo-three-dimensional images using focal illumination, which gives high contrast to samples.

Related Products

ECLIPSE Ts2R / Ts2R-FL

A compact inverted microscope for your basic research needs.

Ts2R/Ts2R-FL provides a wide range of observation methods and applications in a compact body that can easily fit in limited laboratory spaces while providing streamlined operation.

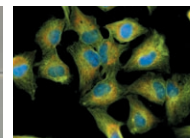
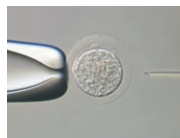

Specifications and equipment are subject to change without any notice or obligation on the part of the manufacturer. November 2017 ©2016-2017 NIKON CORPORATION

N.B. Export of the products* in this catalog is controlled under the Japanese Foreign Exchange and Foreign Trade Law. Appropriate export procedures shall be required in case of export from Japan.

*Products: Hardware and its technical information (including software)

WARNING

TO ENSURE CORRECT USAGE, READ THE CORRESPONDING MANUALS CAREFULLY BEFORE USING THE EQUIPMENT.



NIKON CORPORATION

Shinagawa Intercity Tower C, 2-15-3,
Konan, Minato-ku, Tokyo 108-6290, Japan
phone: +81-3-6433-3705 fax: +81-3-6433-3785
<http://www.nikon.com/products/microscope-solutions/>

ISO 14001 Certified
for NIKON CORPORATION

NIKON INSTRUMENTS INC.

1300 Walt Whitman Road, Melville, N.Y. 11747-3064, U.S.A.
phone: +1-631-547-8500; +1-800-52-NIKON (within the U.S.A. only)
fax: +1-631-547-0306

<http://www.nikoninstruments.com/>

NIKON INSTRUMENTS EUROPE B.V.

Tripolis 100, Burgenweeshuispad 101, 1076 ER Amsterdam, The Netherlands
phone: +31-20-7099-0000 fax: +31-20-7099-298

<http://www.nikoninstruments.eu/>

NIKON INSTRUMENTS (SHANGHAI) CO., LTD.

CHINA phone: +86-21-6841-2050 fax: +86-21-6841-2060
(Beijing branch) phone: +86-10-5831-2028 fax: +86-10-5831-2026
(Guangzhou branch) phone: +86-20-3882-0550 fax: +86-20-3882-0580

NIKON CANADA INC.

CANADA phone: +1-905-602-9676 fax: +1-905-602-9953

NIKON FRANCE S.A.S.

FRANCE phone: +33-1-4516-45-16 fax: +33-1-4516-45-55

NIKON GMBH

GERMANY phone: +49-211-941-42-20 fax: +49-211-941-43-22

NIKON INSTRUMENTS S.p.A.

ITALY phone: +39-55-300-96-01 fax: +39-55-30-09-93

NIKON GMBH SWITZERLAND

SWITZERLAND phone: +41-43-277-28-67 fax: +41-43-277-28-61

NIKON UK LTD.

UNITED KINGDOM phone: +44-208-247-1717 fax: +44-208-541-4584

NIKON CEE GMBH

AUSTRIA phone: +43-1-972-6111 fax: +43-1-972-611-140

NIKON SINGAPORE PTE LTD.

SINGAPORE phone: +65-6559-3651 fax: +65-6559-3668

NIKON INSTRUMENTS KOREA CO., LTD.

KOREA phone: +82-2-2186-8400 fax: +82-2-555-4415